

> **Features**

- High Speed Switching
- Low On-Resistance
- No Secondary Breakdown
- Low Driving Power
- High Voltage
- VGS = ± 30V Guarantee
- Repetitive Avalanche Rated

> **Applications**

- Switching Regulators
- UPS
- DC-DC converters
- General Purpose Power Amplifier

> **Maximum Ratings and Characteristics**

- Absolute Maximum Ratings (TC=25°C), unless otherwise specified

| Item | Symbol | Rating | Unit |
|--|----------------------|------------|------|
| Drain-Source-Voltage | V _{DS} | 450 | V |
| Continous Drain Current | I _D | 18 | A |
| Pulsed Drain Current | I _{D(puls)} | 72 | A |
| Gate-Source-Voltage | V _{GS} | ±30 | V |
| Repetitive or Non-Repetitive (T _{ch} ≤ 150°C) | I _{AR} | 18 | A |
| Avalanche Energy | E _{AS} | 185 | mJ |
| Max. Power Dissipation | P _D | 125 | W |
| Operating and Storage Temperature Range | T _{ch} | 150 | °C |
| | T _{stg} | -55 ~ +150 | °C |

> **Outline Drawing**

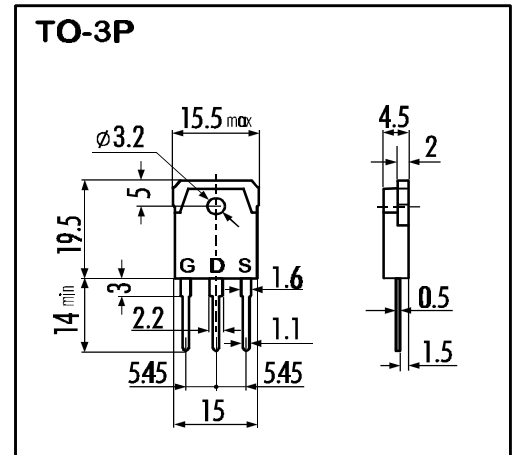

> **Equivalent Circuit**



- Electrical Characteristics (TC=25°C), unless otherwise specified

| Item | Symbol | Test conditions | Min. | Typ. | Max. | Unit |
|---|----------------------|---|------|------|------|------|
| Drain-Source Breakdown-Voltage | V _{(BR)DSS} | I _D =1mA V _{GS} =0V | 450 | | | V |
| Gate Threshold Voltage | V _{GS(th)} | I _D =1mA V _{DS} =V _{GS} | 3,5 | 4,0 | 4,5 | V |
| Zero Gate Voltage Drain Current | I _{DSS} | V _{DS} =450V T _{ch} =25°C | | 10 | 500 | μA |
| | | V _{GS} =0V T _{ch} =125°C | | 0,2 | 1,0 | mA |
| Gate Source Leakage Current | I _{GSS} | V _{GS} =±30V V _{DS} =0V | | 10 | 100 | nA |
| Drain Source On-State Resistance | R _{DS(on)} | I _D =9A V _{GS} =10V | | 0,4 | 0,45 | Ω |
| Forward Transconductance | g _{fs} | I _D =9A V _{DS} =25V | 4,5 | 9 | | S |
| Input Capacitance | C _{iss} | V _{DS} =25V | | 1400 | 2100 | pF |
| Output Capacitance | C _{oss} | V _{GS} =0V | | 250 | 380 | pF |
| Reverse Transfer Capacitance | C _{rss} | f=1MHz | | 110 | 170 | pF |
| Turn-On-Time t _{on} (t _{on} =t _{d(on)} +t _r) | t _{d(on)} | V _{CC} =300V | | 30 | 50 | ns |
| | t _r | I _D =18A | | 140 | 210 | ns |
| Turn-Off-Time t _{off} (t _{off} =t _{d(off)} +t _f) | t _{d(off)} | V _{GS} =10V | | 80 | 120 | ns |
| | t _f | R _{GS} =10 Ω | | 60 | 90 | ns |
| Avalanche Capability | I _{AV} | L = 100μH T _{ch} =25°C | 18 | | | A |
| Diode Forward On-Voltage | V _{SD} | I _F =2xI _{DR} V _{GS} =0V T _{ch} =25°C | | 1,1 | 1,65 | V |
| Reverse Recovery Time | t _{rr} | I _F =I _{DR} V _{GS} =0V | | 500 | | ns |
| Reverse Recovery Charge | Q _{rr} | -dI _F /dt=100A/μs T _{ch} =25°C | | 6,5 | | μC |

- Thermal Characteristics

| Item | Symbol | Test conditions | Min. | Typ. | Max. | Unit |
|--------------------|-----------------------|-----------------|------|------|------|------|
| Thermal Resistance | R _{th(ch-a)} | channel to air | | | 35 | °C/W |
| | R _{th(ch-c)} | channel to case | | | 1,0 | °C/W |

| | | | |
|-------------------|-------|-----|------|
| N-channel MOS-FET | | | |
| 450V | 0,45Ω | 18A | 125W |

2SK2755-01

FAP-IIS Series



> Characteristics

Typical Output Characteristics

$I_D = f(V_{DS})$; 80μs pulse test; $T_{ch} = 25^\circ\text{C}$

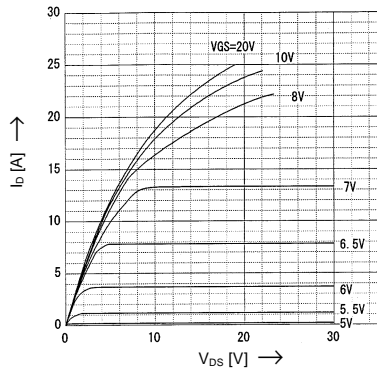

Drain-Source On-State Resistance vs. T_{ch}

$R_{DS(on)} = f(T_{ch})$; $I_D = 9\text{A}$; $V_{GS} = 10\text{V}$

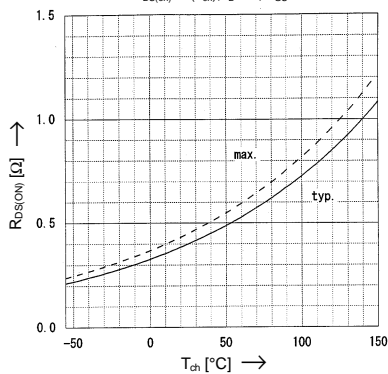

Typical Transfer Characteristics

$I_D = f(V_{GS})$; 80μs pulse test; $V_{DS} = 25\text{V}$; $T_{ch} = 25^\circ\text{C}$

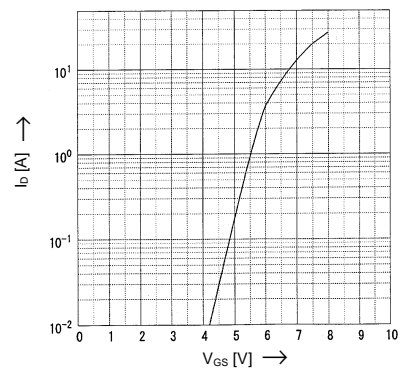

Typical Drain-Source On-State-Resistance vs. I_D

$R_{DS(on)} = f(I_D)$; 80μs pulse test; $T_{ch} = 25^\circ\text{C}$

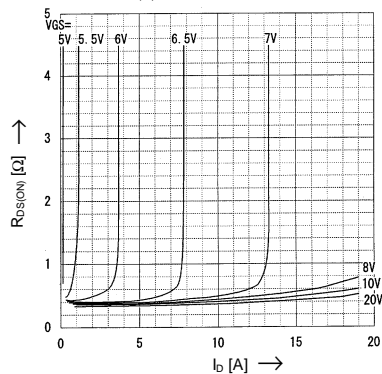

Typical Forward Transconductance vs. I_D

$g_{fs} = f(I_D)$; 80μs pulse test; $V_{DS} = 25\text{V}$; $T_{ch} = 25^\circ\text{C}$

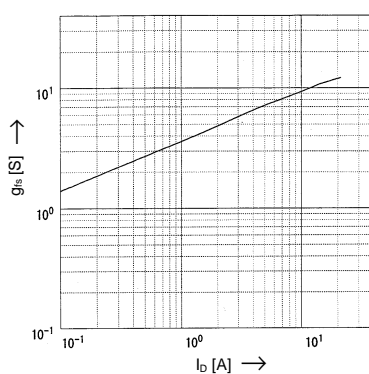

Gate Threshold Voltage vs. T_{ch}

$V_{GS(th)} = f(T_{ch})$; $I_D = 1\text{mA}$; $V_{DS} = V_{GS}$

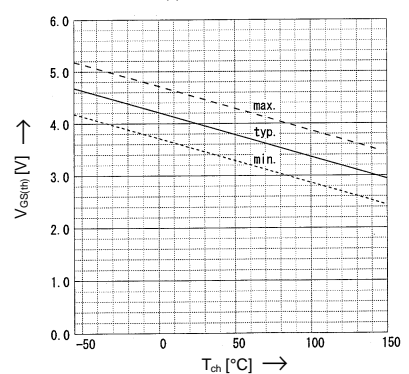

Typical Capacitances vs. V_{DS}

$C = f(V_{DS})$; $V_{GS} = 0\text{V}$; $f = 1\text{MHz}$

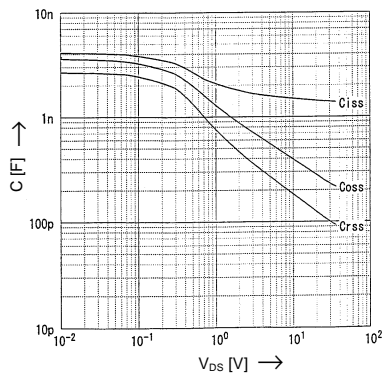

Typical Gate Charge Characteristic

$V_{GS} = f(Q_g)$; $I_D = 18\text{A}$; $T_{ch} = 25^\circ\text{C}$

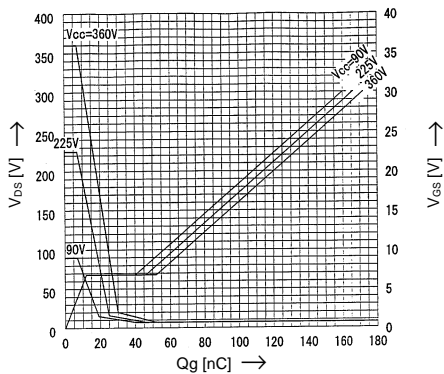

Forward Characteristics of Reverse Diode

$I_F = f(V_{SD})$; 80μs pulse test; $V_{GS} = 0\text{V}$

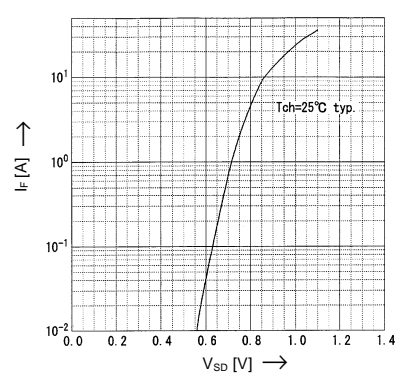

Avalanche Energy Derating

$E_{as} = f(\text{starting } T_{ch})$; $V_{CC} = 45\text{V}$; $I_{AV} = 18\text{A}$

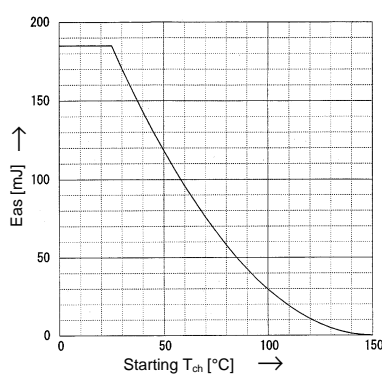

Safe Operation Area

$I_D = f(V_{DS})$; $D = 0.01$; $T_{ch} = 25^\circ\text{C}$

